

Especificaciones Técnicas

Carpintería Corredera

Cerco y Hoja Perimetral

Sección de Marco 60 mm.

Sección de Hoja 24 x 58 mm.

Galce de vidrio hasta 18 mm.

Peso Máximo por Hoja : 50 Kg.

Posibilidad de colocación de Herraje Multipunto Corredera

Clasificación obtenida

Permeabilidad al aire*	CLASE 3
Estanqueidad al agua*	CLASE 6A
Resistencia al viento*	CLASE C1
Transmitancia térmica**	3,8 W(m ² K)
Aislamiento acústico***	29 (-1;-2)dB

* Ventana de 2 hojas de 1230 x 1480 mm.

** Ventana de 2 hojas de 1480 x 2180 mm.con cajón de persiana ; Vidrio 4-10-4

*** Ventana de 2 hojas de 1230 x 1480 mm ; Vidrio 4-6-4

Posibilidades de Apertura

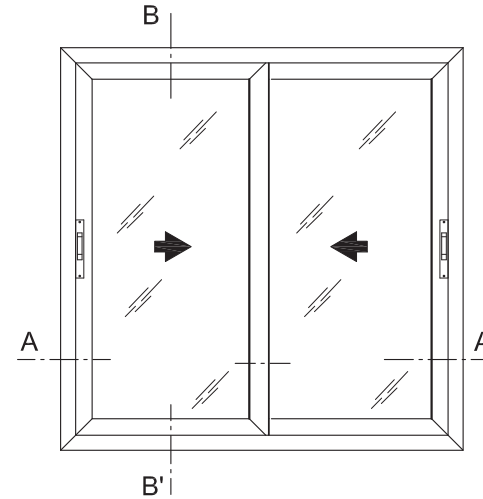
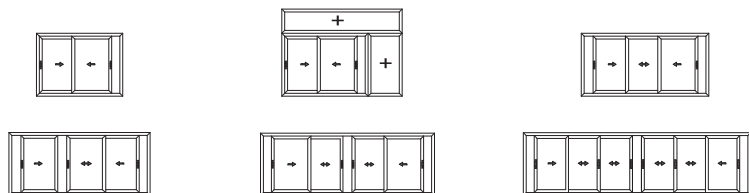

VENTANA DE 2 HOJAS CORREDERAS

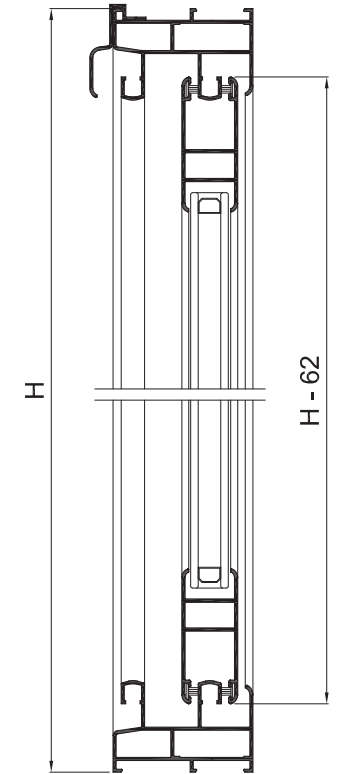

Sección B-B'

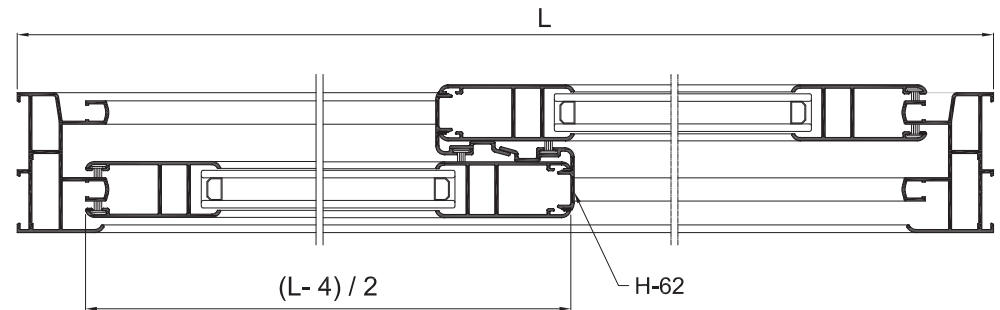

Sección A-A'

Perfiles

Silver - 60

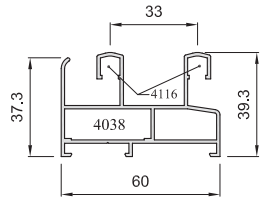

S8520 (8520)

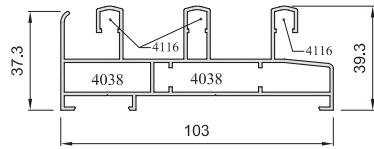

S8519 (8519)

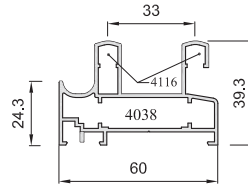

S8547 (8547)

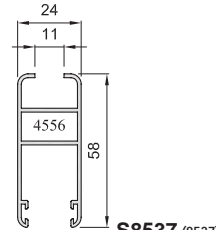

S8537 (8537)

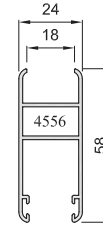

S8560 (8560)

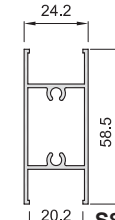

S8539 (8539)

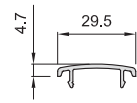

784

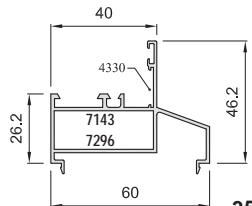

3506 (497)

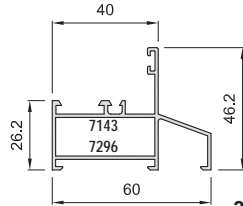

3504 (496)

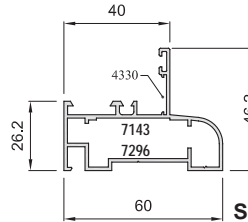

S8593 (8593)

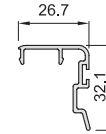

S8538 (8538)

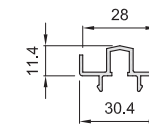

S8569 (8569)

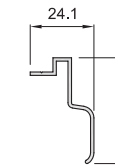

S8521 (8521)

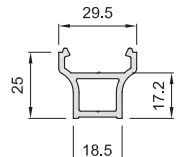

783

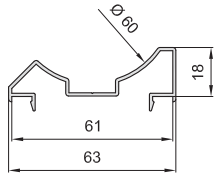

2050 (507)

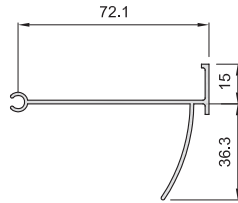

2039 (610)

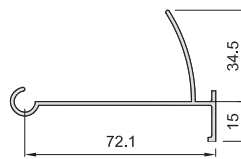

2040 (611)

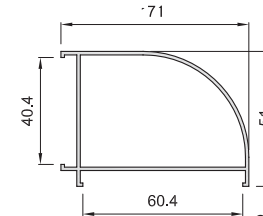

3849 (506)

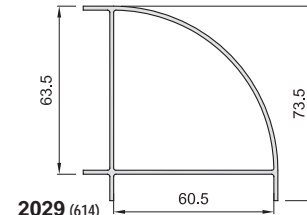

2029 (614)

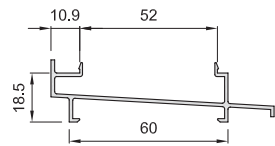

2545 (462)

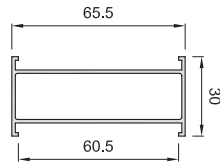

2059 (511)

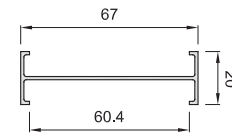

2033 (613)

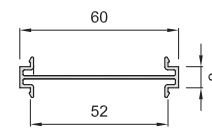

2566 (466)

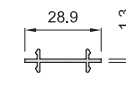

S8589 (8589)

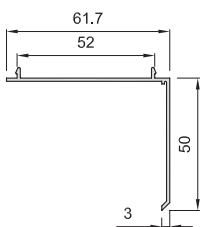

2537 (871)

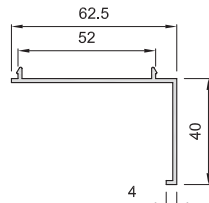

2527 (486)

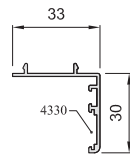

2327 (327)

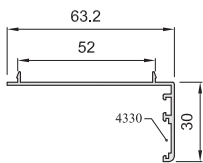

2580 (461)

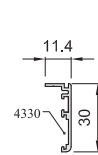

2181 (281)

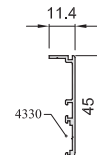

S8629 (8629)

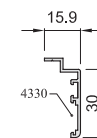

S8832 (8832)

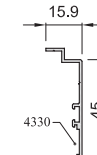

S8630 (8630)

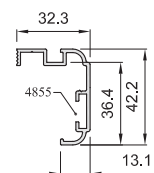

S8893 (8893)



Accesorios

Silver - 60

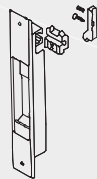

4551

Cierre embutido peque.
s/condena

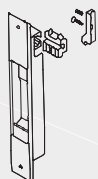

4558

Cierre embutido
peque. c/condena

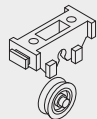

4126

Rueda sencilla nylon

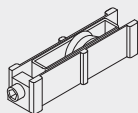

4102

Rueda regulable (Zamak)



4107

Embellecedor acop.
hoja central

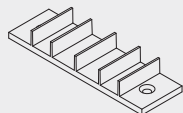

4553

Cortavientos
Silver-60/70

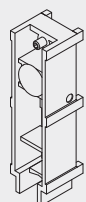

4182
Tope Guía
(Jgo. 4)

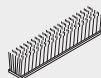

7792

Felpudo Fean Seal
7 x 6 mm.

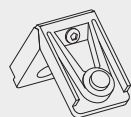

4038

Escuadra Cerco



4556

Escuadra Hoja



4116

Escuadra alineamie.
carriles



4109

Escuadra
Alineamiento hojas



4176

Válvula de
drenaje

CIERRE MULTIPUNTO E: 7.5 mm

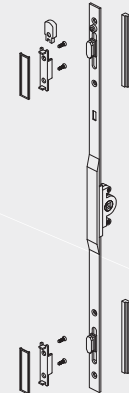

4187

Cierre multipunto
H = 668 - 1068

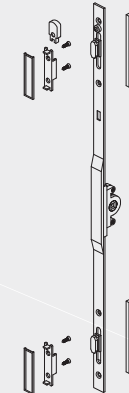

4188

Cierre multipunto
H = 1069-1868

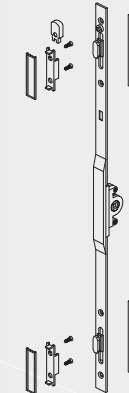

4189

Cierre multipunto
H > 1869

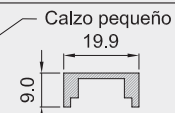

4190

Manilla
cuadrado 7 mm.



4858(D) / 4859(I)
Manilla corredera
acodada
cuadrado 7 mm.

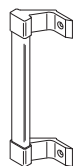

7349 (4153)

Tirador grande



4118

Terminal acople
4 hojas



4339

Juego tapas
tirador postizo
(783-4)

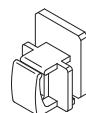

4125

Tope hoja lateral



4855

Escuadra solapa 8893



4039

Escuadra inox.
alineamiento



7296 (3627)

Escuadra pulsante
para fijos

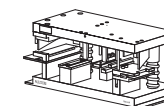

4555

Util múltiple
Silver-60/70