

CERRAMIENTO CON LAMAS ORIENTABLES PARA CONTROLAR EL SOLEAMIENTO DE FACHADA

Carpintería Mallorquina Corredera sobre muro exterior, guiada mediante carros de rodamientos que se deslizan por el cerco superior. Este sistema posibilita aperturas correderas de una y dos hojas. Amplía gama de perfiles, que facilitan la composición de diferentes diseños así como múltiples posibilidades en su puesta en obra.

CARACTERÍSTICAS TÉCNICAS.

Carpintería Mallorquina corredera sin Rotura del puente térmico.

- Sección de marco superior: 97,5 mm.
- Sección marco inferior: 102 mm.
- Sección de hoja: 40 mm.
- Lama fija: 50 mm.
- Lama móvil: 66 y 71 mm.

CLASIFICACIÓN OBTENIDA.

Todo el sistema Mallorquina, está comprendido bajo las normas AENOR ISO 9001 y 14001

SECCIÓN 2D

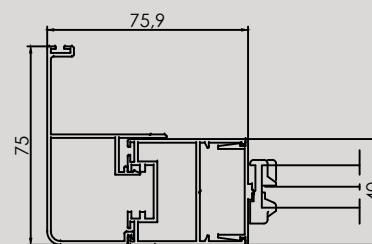

PESOS Y MEDIDAS MÁXIMAS

- Peso máximo:
Peso por hoja: 180 Kg



IMAGEN 3D

POSIBILIDADES DE APERTURA

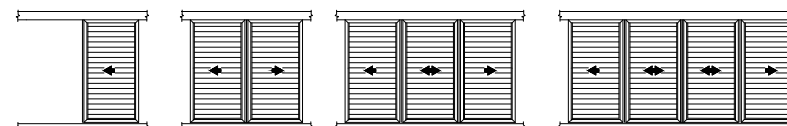

SECCION B - B'

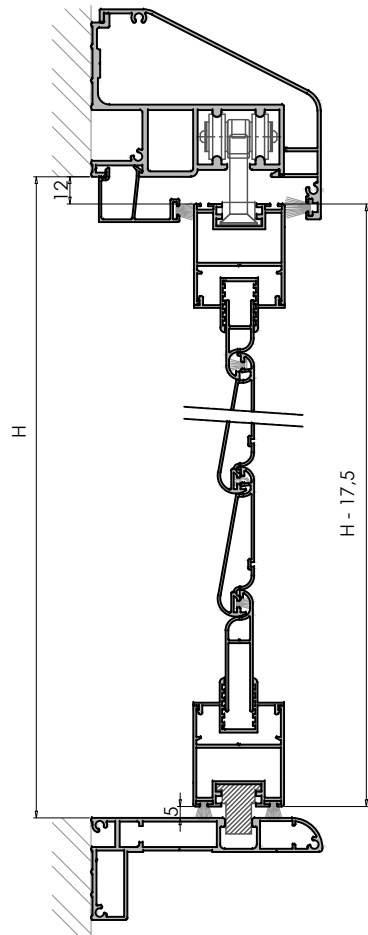

PERFIL	Ref. / DENOMINACION		Uds. / Corte		
	S8375	MARCO SUPERIOR	1	2L + 48	90°
	S8377	TAPA MARCO SUPERIOR	1	2L + 48	90°
	S8371	MARCO INFERIOR	1	2L + 48	90°
	S8373	HOJA	4 4	L - 48/2 H - 17,5	45° 45°
	S8372	TAPA LATERAL	2	H - 17,5	90°
	S8302	POSICIONADOR	4	L - 282/2	90°
	S8312	LAMA ORIENTABLE	N	L - 251/2	90°
	S8313	COMPENSADOR CORTO	2	L - 273,5/2	90°
	S8314	COMPENSADOR LARGO	2	L - 273,5/2	90°

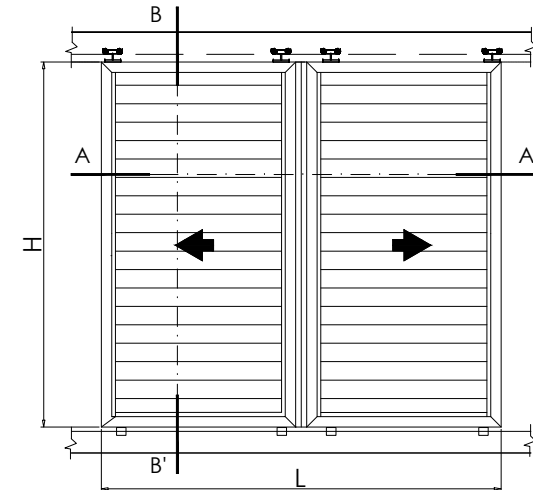

SECCION A - A'

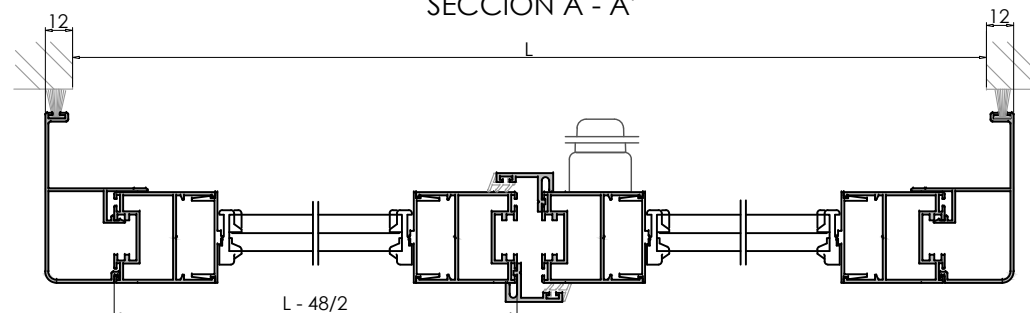

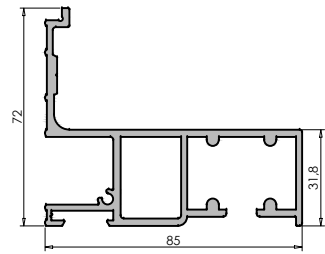

S8375
(8375)

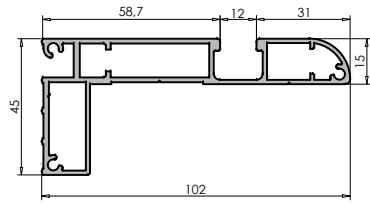

S8371
(8371)

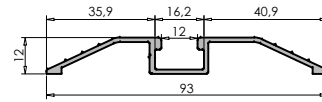

S8370
(8370)

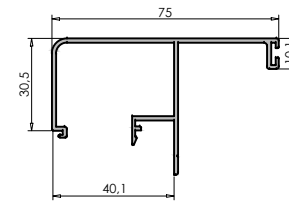

S8372
(8372)

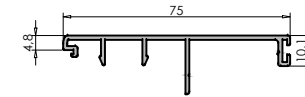

S8376
(8376)

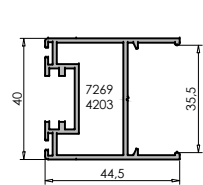

S8373
(8373)

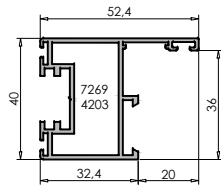

S8027
(8027)

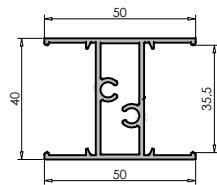

S8317
(8717)

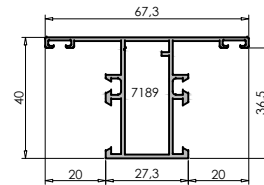

3520
(303)

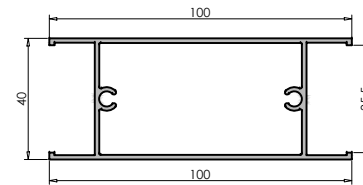

S8585
(8585)

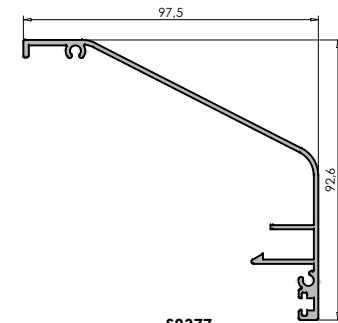

S8377
(8377)

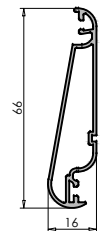

S8312
(8312)

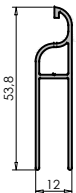

S8312
(8312)

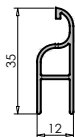

S8313
(8313)



S8309
(8309)

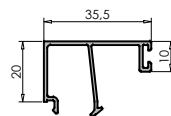

S8450
(8450)

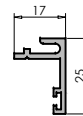

S8023
(8023)



8412

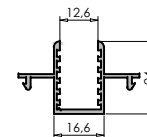

S8302
(8302)

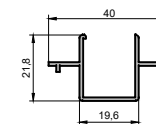

S8310
(8310)



7296

ESCUADRA PULSANTE VENT. DESCENT.



4304

ESCUADRA ALINEAMIENTO SOLAPES

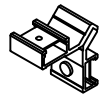

4203

ESCUADRA CERCO HOJA



7189

TACO PILASTRA VENTANA

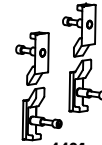

4481

KIT DE TRANSMISIÓN



4246

MANDO JOLLY



4247

MANDO ESFERA

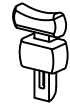

4248

MANDO SLIM



4453

TACO TIPO LAMA FIJA "Z"



4454

TACO COMPENSADOR LAMA FIJA "Z"



4455

POSICIONADOR FIJO CIERRE TOTAL



4456

POSICIONADOR FIJO APERTURA 60°



4457

COMPENSADOR EXTREMO

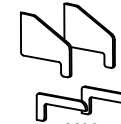

4482

JGO TAPAS SUP. E INF CHAPA

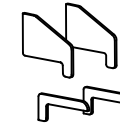

4483

JGO TAPAS SUP. E INF PLÁSTICO



4973

FELPUDO 7 x 10 + 2 mm



4971

FELPUDO FIN SEAL 7 X 15 mm



4208

GOMA AJUSTE ENTRE LAMAS



4259

LAMA UNIÓN VERT. ENTRE HOJAS



4739

TERMINAL PLETINA METÁLICO



4003

TERMINAL PLETINA CREMONA

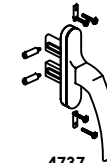

4737

CREMONA AP. EXT. PATILLAS BALCÓN