

SERIE 3300

A96

Imagen



Características Técnicas

- Aleación de Extrusión:**
 - 6063 (UNE 38-337)
- Estado de Suministro:**
 - T5 (UNE 38-002)
- Tipo de Estanqueidad al Aire-Agua:**
 - Triple junta de estanqueidad en EPDM.
- Dimensiones:**
 - Marco de 40 mm. y Hoja de 47 mm.
 - Espesor medio de 1,3 mm. en perfiles de ventana y de 1,4 mm. en perfiles de puerta
 - Corte a inglete 45°
- Tipos de Tapajuntas:**
 - Clip, Grapa y Atornillado.
- Hueco de Acrilamiento:**
 - La perfilera permite vidrios de entre 8 y 24 mm.
- Accesorios:**
 - Ensamblés con escuadras, tacos y tornillos.
 - Escuadras de alineamiento metálicas.
- Canal de Herrajes:**
 - Cámara Europea.
- Tratamiento Superficial:**
 - Lacado: Con certificación QUALICOAT.
 - Anodizado: Con calidad QUALANOD.

Marcado CE

Ventana de 1,82 m ²	Aire	Agua	Viento	Acústica dB	Térmica W / m ²	Cargas
	3	E750	C5	29 (-1;-3)	3,0	APTO

Transmitancia Térmica calculada para carpintería de 4,10 m² con vidrio bajo emisivo 4/16/4

Atenuación Acústica calculada para carpintería con una superficie inferior a 2,44 m² y un vidrio 4/8/4

Permeabilidad al Aire:	UNE - EN 1026:2000
Estanqueidad al Agua:	UNE - EN 1027:2000
Resistencia al Viento:	UNE - EN 12211:2000
Resistencia a la Torsión:	UNE - EN 14609:2004
Aislamiento Acústico:	UNE - EN ISO 140-3:1995
Transmisión Térmica:	UNE - EN ISO10077-2:2008

Aperturas

Ventanas

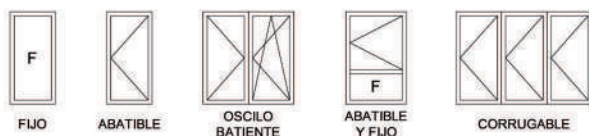

Puertas y Balconeras



Sección

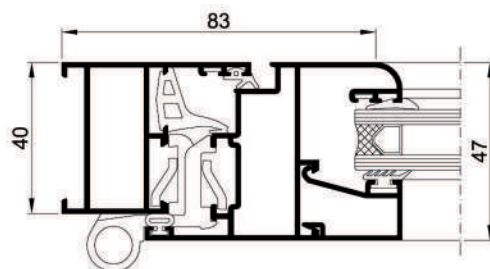

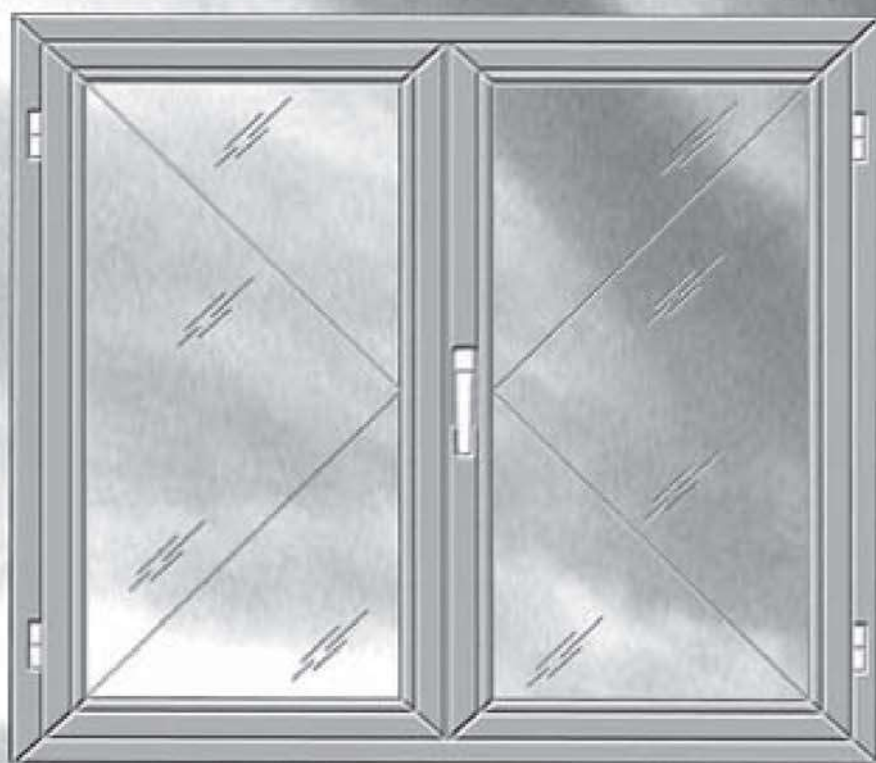

SERIE 3300

ABATIBILE EUROPEA

DETALLE DE FIJACION A OBRA DE LAS VENTANAS DE PUENTE TÉRMICO

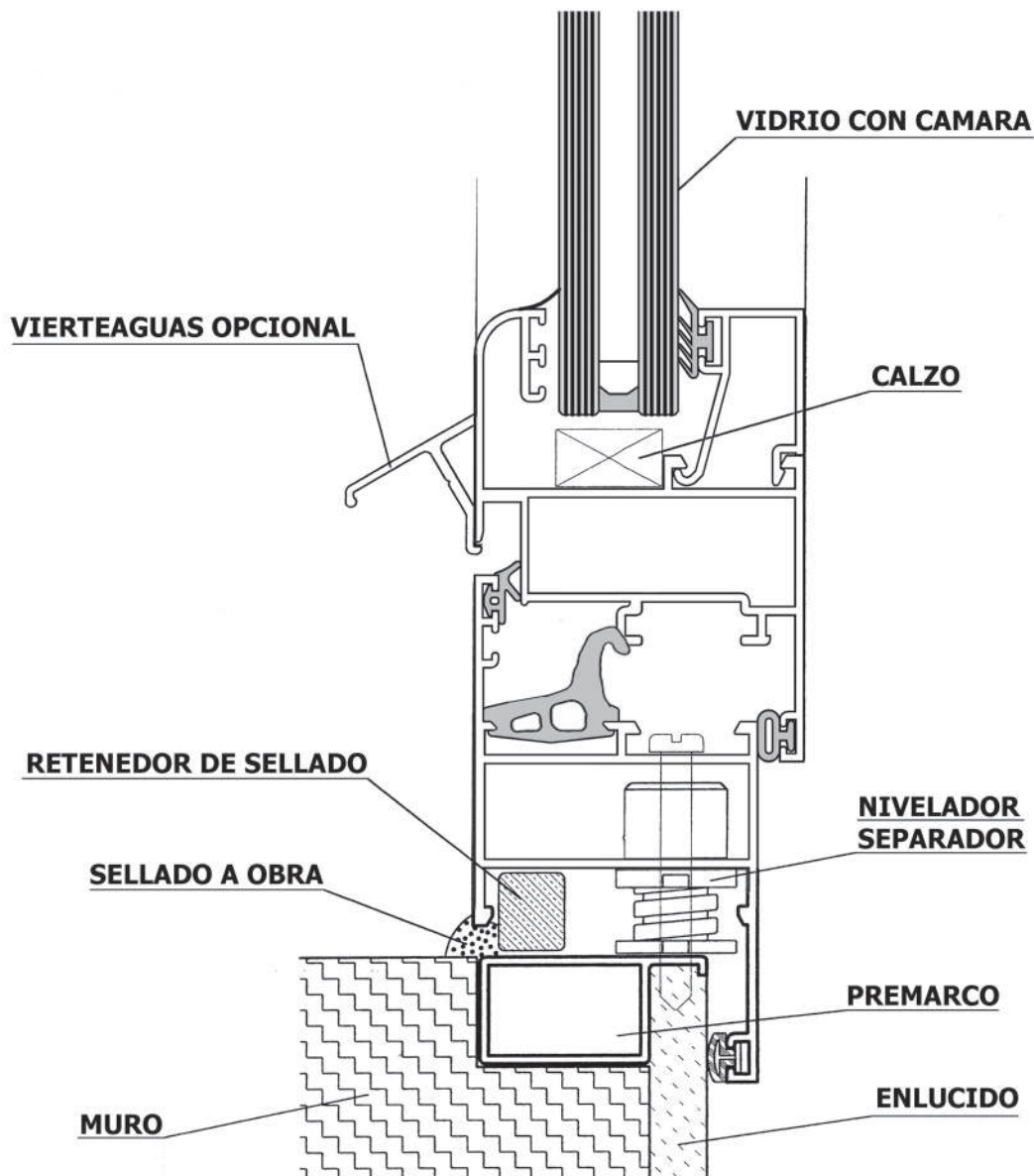

OBSERVACIONES:

SE DEBERÁ TENER SIEMPRE EN CUENTA, PARA QUE EXISTA UNA ROTURA MÁXIMA, QUE EL VIDRIO ESTE TOTALMENTE AISLADO DE LOS PERFILES, ASI COMO LOS PERFILES COMPONENTES DEL CERCO DE LA VENTANA HAN DE ESTAR TOTALMENTE SEPARADOS DEL PREMARCO Y DEL MURO QUE CONFORMA EL HUECO.

ESTAS NORMAS SON APLICABLES TAMBIEN A LOS PERFILES SIN R.P.T. CON LO QUE SE EVITA UN ALTO PORCENTAJE DE CONDENSACIÓN.



**NOMBRE DEL TALLER
DIRECCION****10**

EN 14351-1

SERIE A96 - Ventana vertical exterior de aluminio con apertura oscilobatiente de 2 Hojas con fijo y con cajón de persiana prevista para su uso en lugares privados y públicos. Acristalamiento 4/8/4



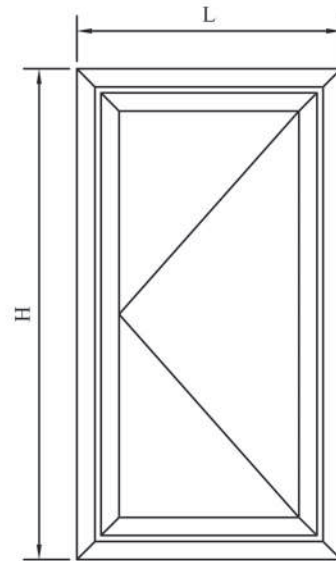
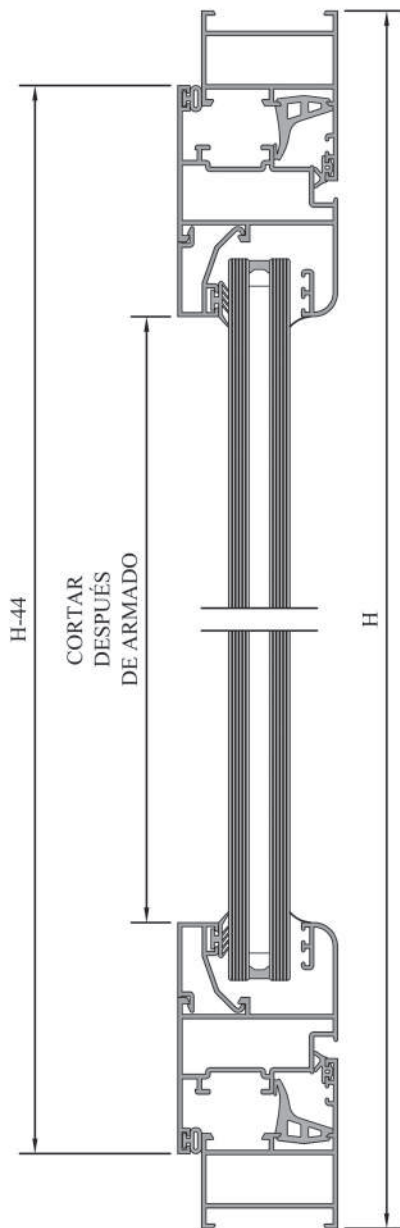

	Ancho	Alto	
Resistencia a la carga de viento:	1380	1770	Clase C3
	1780	2305	Clase C1
Permeabilidad al aire:	1380	1770	Clase 3
	1780	2305	Clase 3
Estanqueidad al agua:	1380	1770	Clase 7A
	1780	2305	Clase 7A
Capacidad de soporte de cargas de los dispositivos de seguridad:			APTO
Prestaciones acústicas	1380	1770	29(-1;-3) dB
Transmitancia Térmica	1380	1770	4.3 W/m²K
	1780	2305	4.2 W/m²K
Sustancias peligrosas			NPD

NOTA: Estaran cubiertas por esta etiqueta las ventanas de dimensiones recogidas por el Anexo-E en la Norma 14351-1.



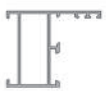
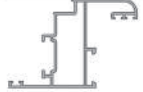

HOJA DE VENTANA DE UNA HOJA PRACTICABLES

	Referencia	Uds	Medida	Corte
	3300 (M-2519)	2	L	HORZ.
	3300 (M-2519)	2	H	VERT.
	3310 (M-2520)	2	L-44	HORZ.
	3310 (M-2520)	2	H-44	VERT.
	3340 (M-2005)	2	CORTAR DESPUÉS DE ARMADO	HORZ.
	3340 (M-2005)	2		VERT.
	8412 (M-2011)	2	SEGÚN ALTURA DE CREMONA	VERT.
 OPCIONAL	5825 (M-4447)	2	L-150	HORZ.
	5825 (M-4447)	2	H-150	VERT.

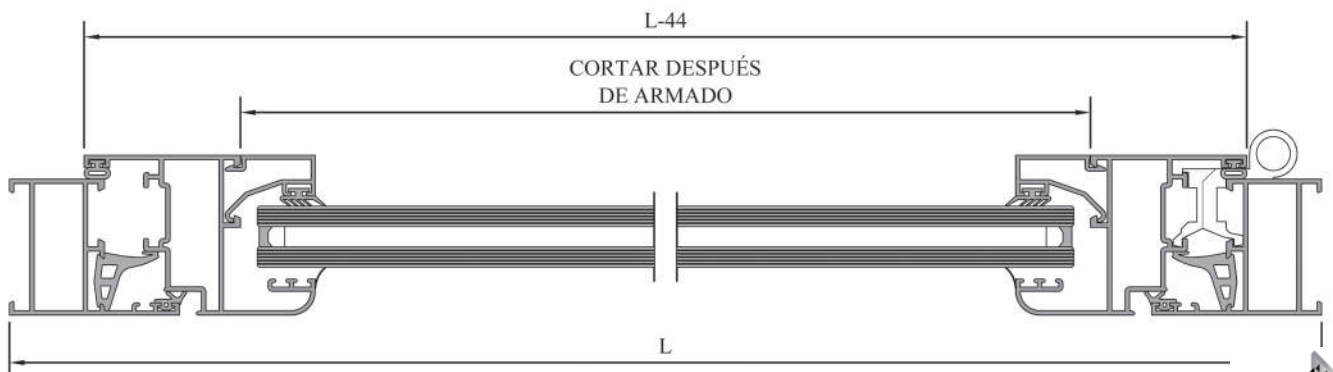

NOTA: Las medidas indicadas son orientativas, pudiendo variar según el tipo de herraje. Rogamos verifiquen las mismas antes de cortar material en serie

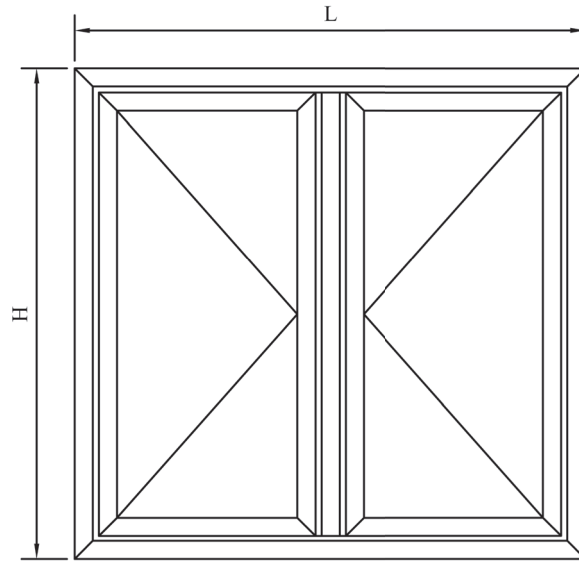
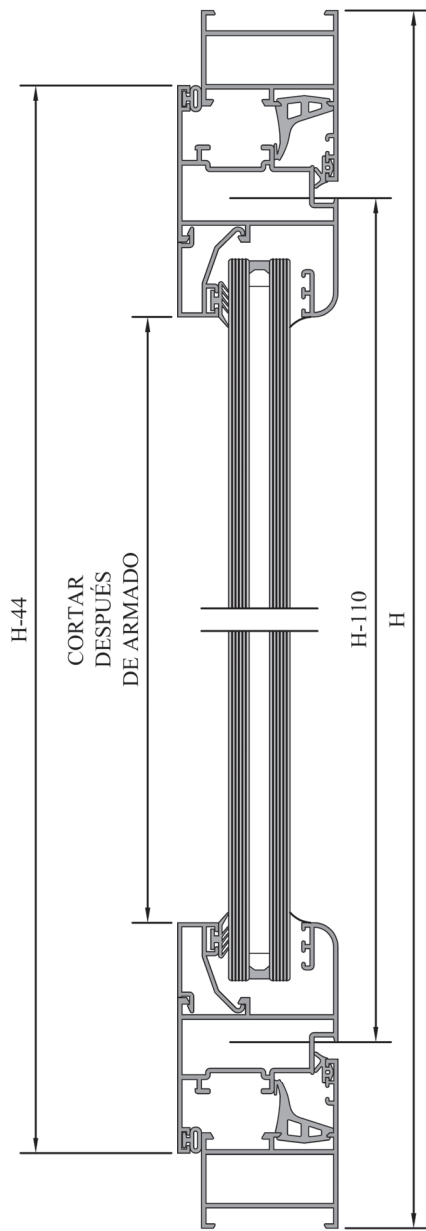

HOJA DE VENTANA DE DOS HOJAS PRACTICABLES



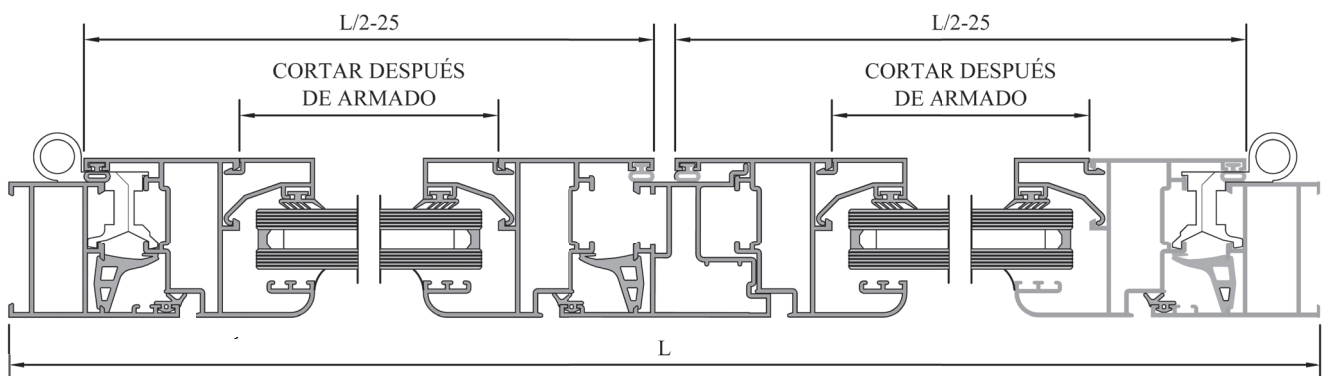
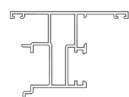

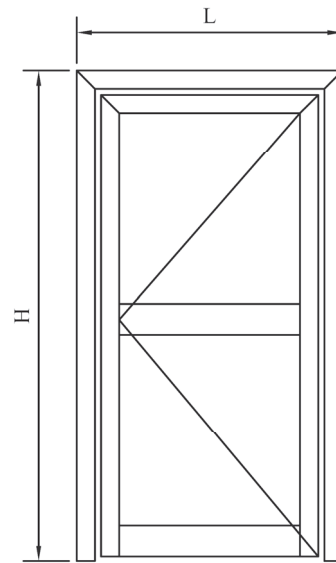
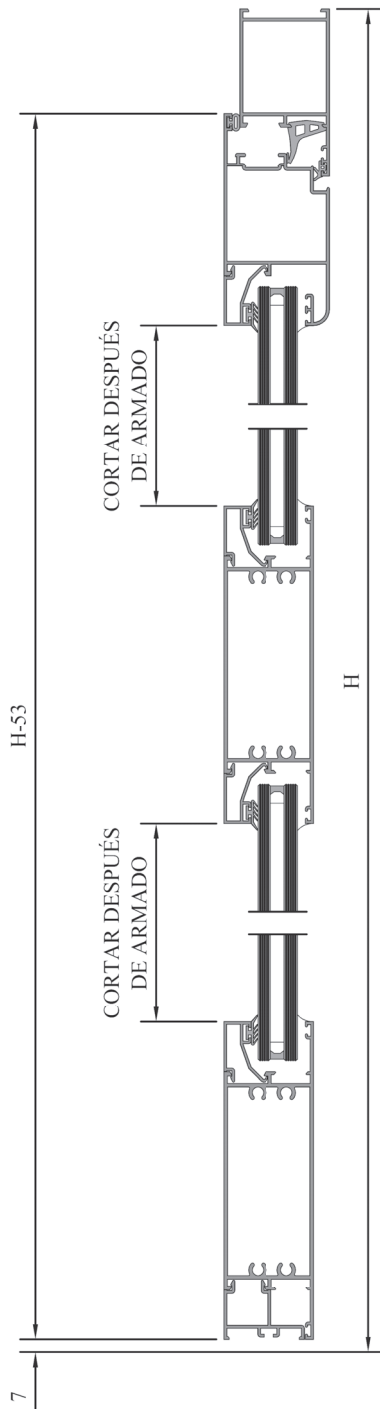

	Referencia	Uds	Medida	Corte
	3300 (M-2519)	2	L	HORZ.
	3300 (M-2519)	2	H	VERT.
	3310 (M-2520)	4	L/2-25	HORZ.
	3310 (M-2520)	4	H-44	VERT.
	3303 (M-2522)	1	H-110	VERT.
	3340 (M-2005)	4	CORTAR DESPUÉS DE ARMADO	HORZ.
	3340 (M-2005)	4		VERT.
	8412 (M-2011)	2	SEGÚN ALTURA DE CREMONA	VERT.
	5825 (M-4447)	4	L/2-131	HORZ.
	5825 (M-4447)	4	H-150	VERT.

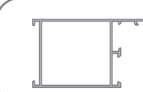

NOTA: Las medidas indicadas son orientativas, pudiendo variar según el tipo de herraje. Rogamos verifiquen las mismas antes de cortar material en serie

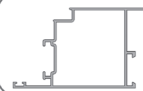
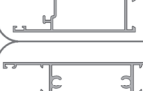
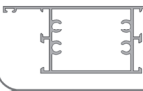

HOJA DE PUERTA DE UNA HOJA APERTURA INTERIOR

	Referencia	Uds	Medida	Corte
	3301 (M-3778)	1	L	HORZ.
	3301 (M-3778)	2	H	VERT.
	3355 (M-2768)	1	L-92	HORZ.
	3355 (M-2768)	2	H-53	VERT.
	3365 (M-2769)	2	L-225 RETESTAR	HORZ.
	3366 (M-2770)	1	L-235 LUCES HOJA	HORZ.
	3339 (M-2384)	4	CORTAR DESPUÉS DE ARMADO	HORZ.
	3339 (M-2384)	4		VERT.
	8412 (M-2011)	2	SEGÚN ALTURA DE CREMONA	VERT.

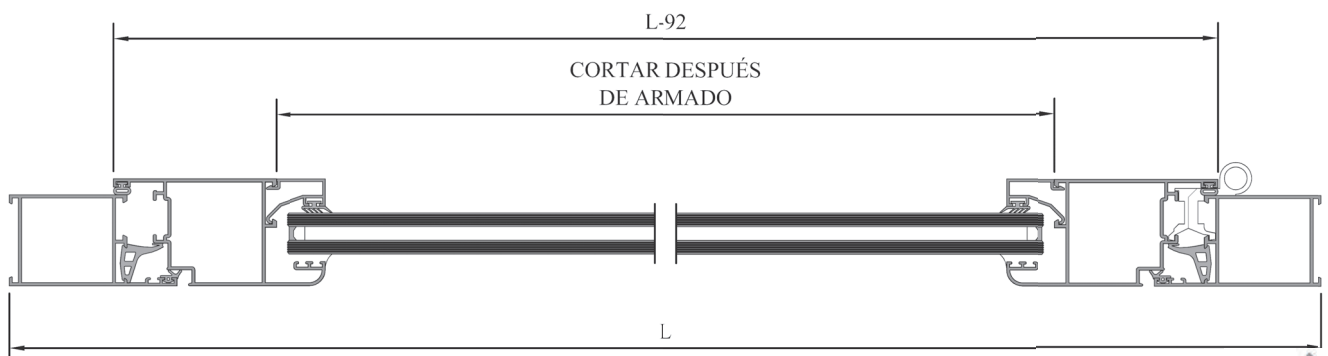

NOTA: Las medidas indicadas son orientativas, pudiendo variar según el tipo de herraje. Rogamos verifiquen las mismas antes de cortar material en serie



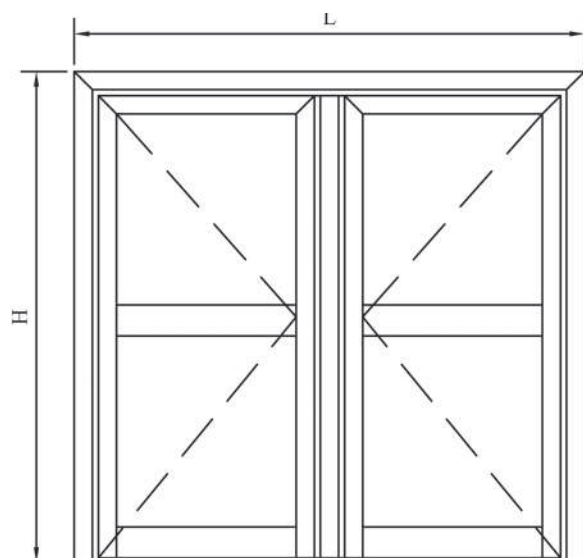
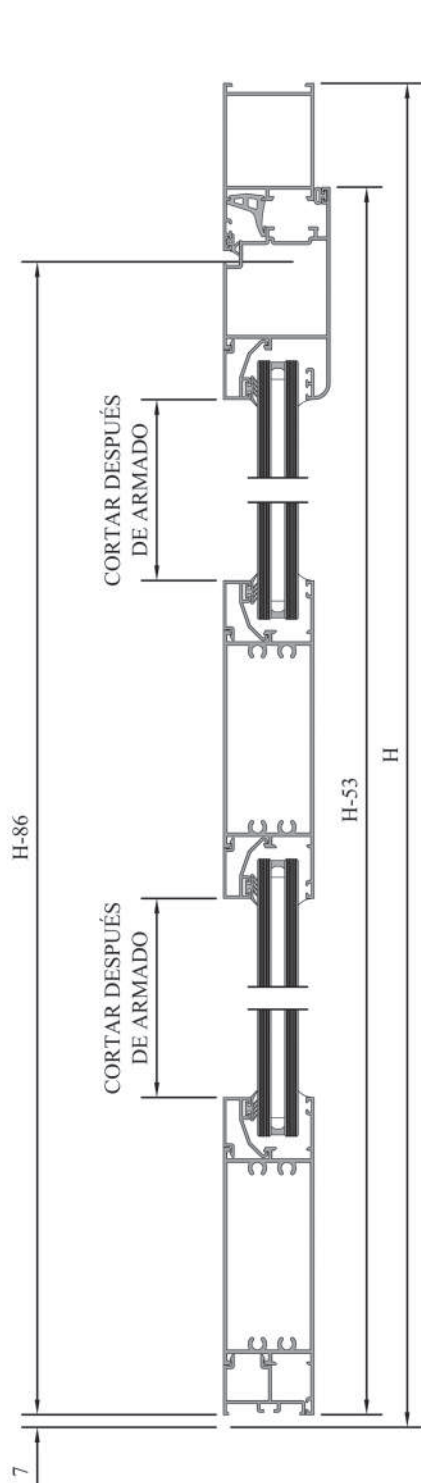

HOJA DE PUERTA DE DOS HOJAS APERTURA EXTERIOR

	Referencia	Uds	Medida	Corte
	3301 (M-3778)	1	L	HORZ.
	3301 (M-3778)	2	H	VERT.
	3358 (M-2813)	2	L/2-49	HORZ.
	3358 (M-2813)	4	H-53	VERT.
	3303 (M-2522)	1	H-86	VERT.
	3365 (M-2769)	4	L/2-182 RETESTAR	HORZ.
	3366 (M-2770)	2	L/2-192 LUCES HOJA	HORZ.
	3340 (M-2005)	8	CORTAR DESPUÉS DE ARMADO	HORZ.
	3340 (M-2005)	8		VERT.
	8412 (M-2011)	2	SEGÚN ALTURA DE CREMONA	VERT.

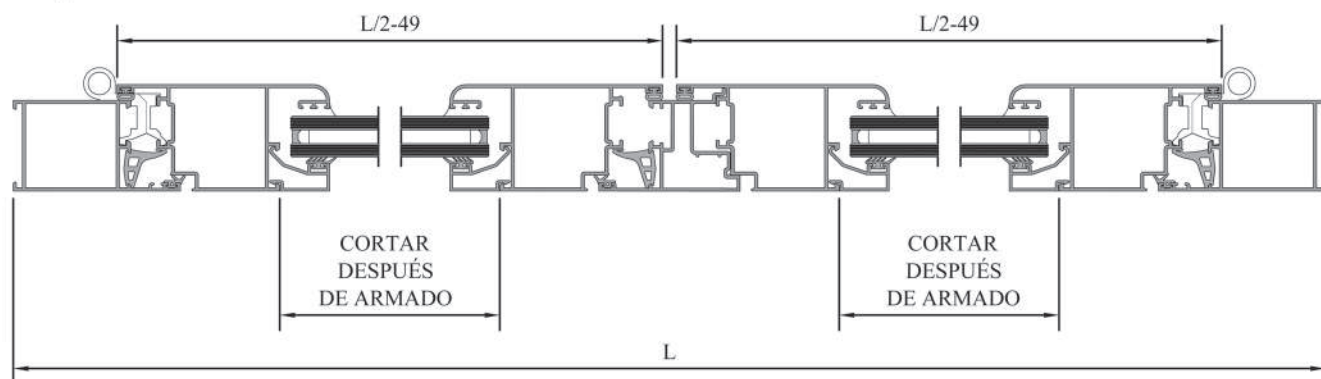

NOTA: Las medidas indicadas son orientativas, pudiendo variar según el tipo de herraje. Rogamos verifiquen las mismas antes de cortar material en serie

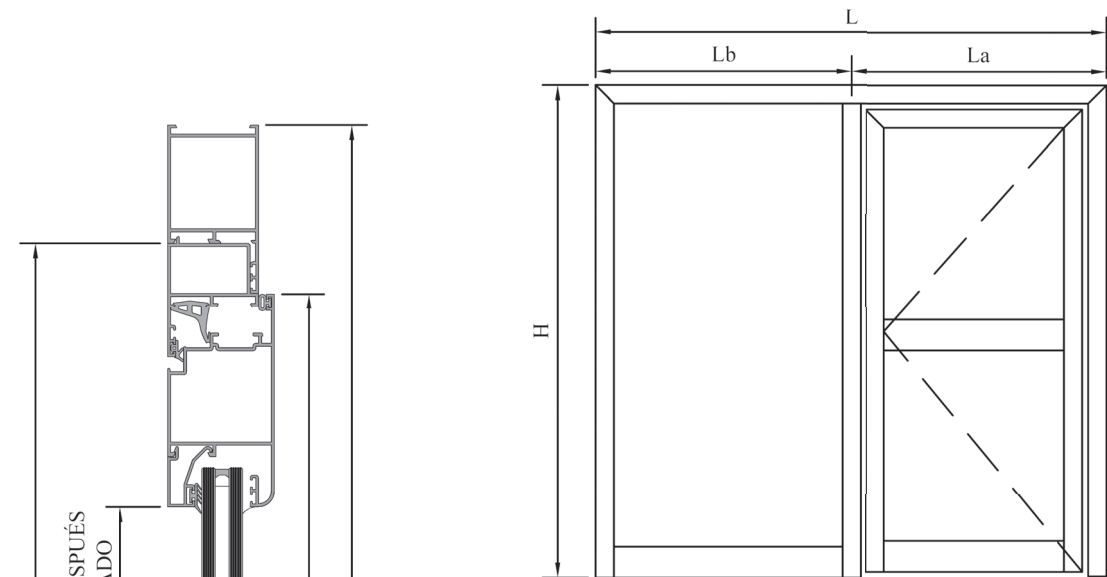

HOJA DE PUERTA DE UNA HOJA CON FIJO APERTURA EXTERIOR

	Referencia	Uds	Medida	Corte
	3301 (M-3778)	1	L	HORZ.
	3301 (M-3778)	2	H	VERT.
	3358 (M-2813)	1	La-123	HORZ.
	3358 (M-2813)	2	H-81	VERT.
	3360 (M-2753)	1	H-47	VERT. RETESTAR
	3357 (M-3864)	1	La-72	HORZ.
	3357 (M-3864)	2	H-49	VERT.
	3365 (M-2769)	2	La-257	HORZ.
	3365 (M-2769)	1	Lb-68	RETESTAR
	3366 (M-2770)	1	La-267	HORZ.
	3366 (M-2770)	1	Lb-78	LUCES HOJA
	3340 (M-2005)	6	CORTAR DESPUÉS DE ARMADO	HORZ.
	3340 (M-2005)	6		VERT.
	8412 (M-2011)	2	SEGÚN ALTURA DE CREMONA	VERT.

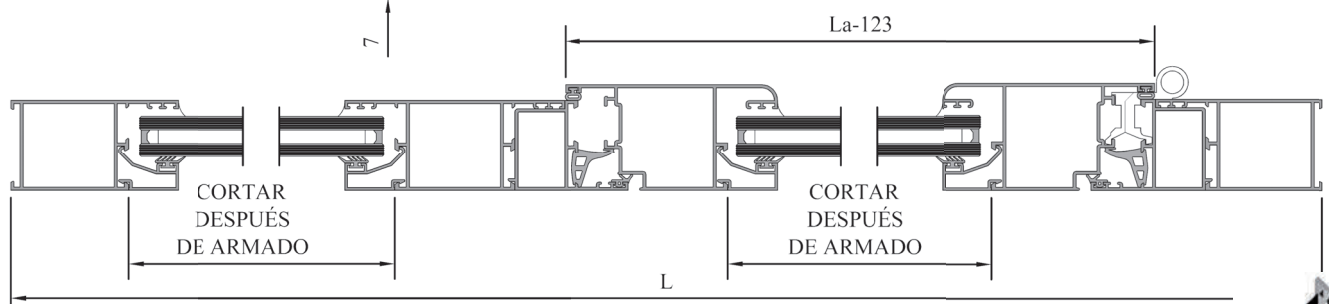

NOTA: Las medidas indicadas son orientativas, pudiendo variar según el tipo de herraje. Rogamos verifiquen las mismas antes de cortar material en serie



SERIE 3300 (A-96)

ABATIBILE EUROPEA

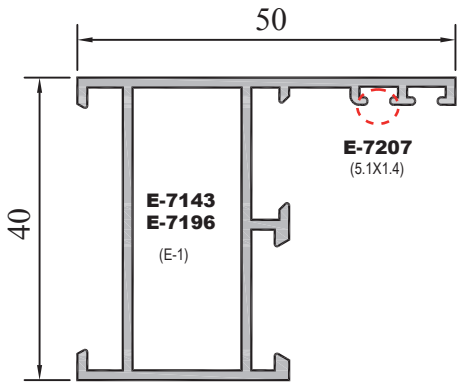

3300 (M-2519)

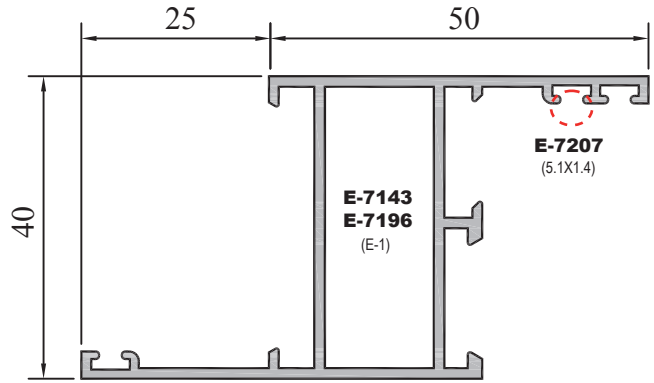

3305 (M-3091)

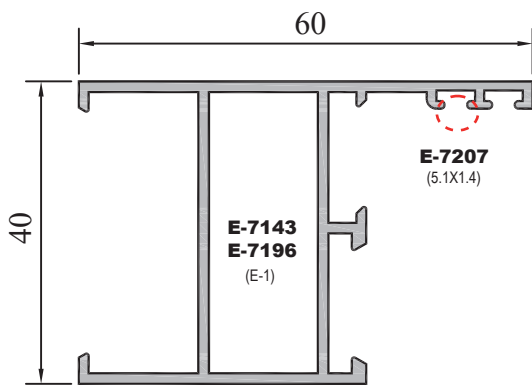

3350 (M-2767)

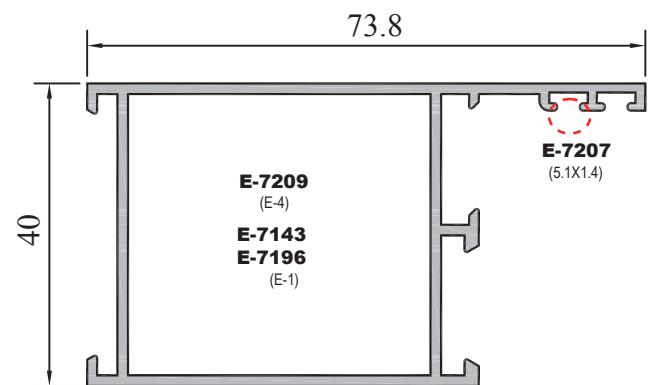

3301 (M-3778)

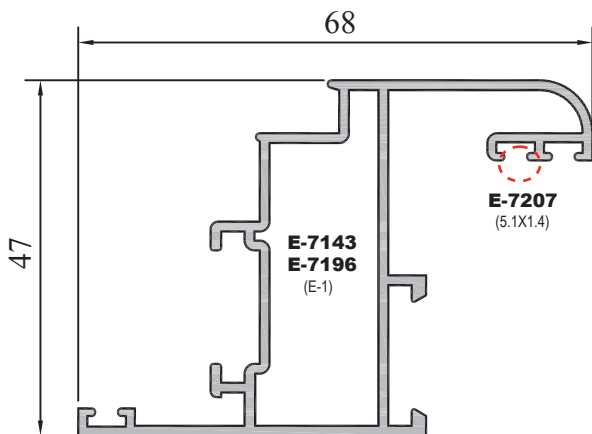

3310 (M-2520)

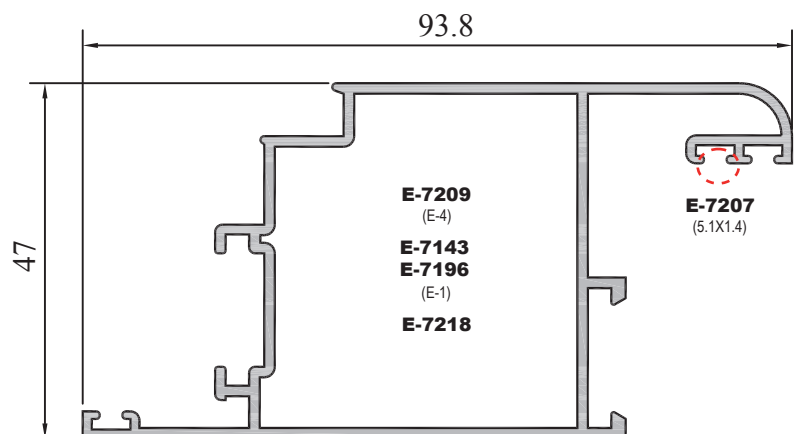

3355 (M-2768)



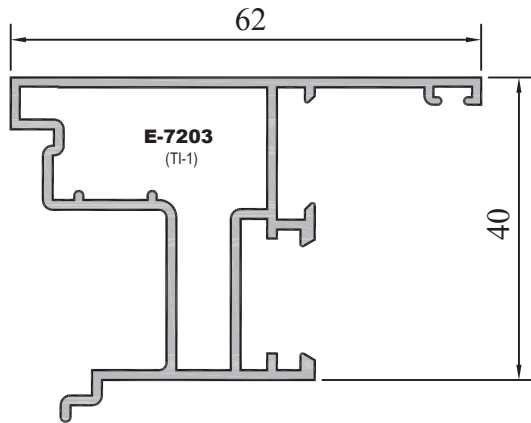

3303 (M-2522)

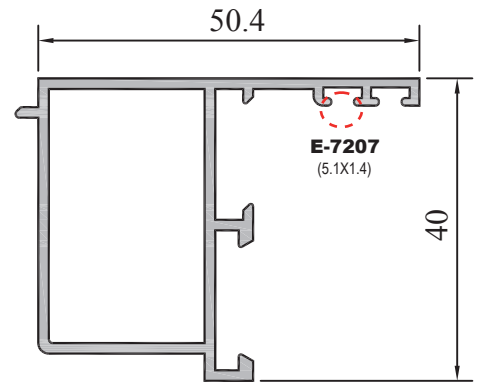

3357 (M-3864)

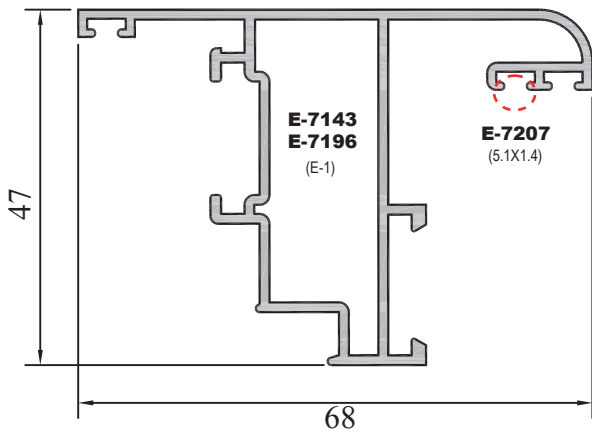

3308 (M-3989)

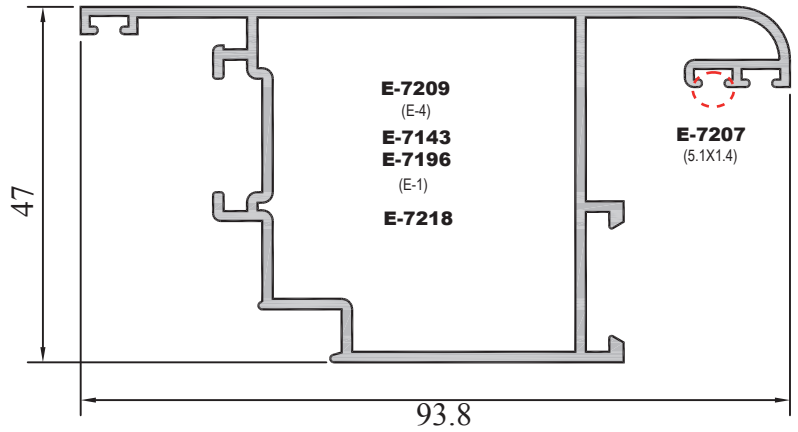

3358 (M-2813)

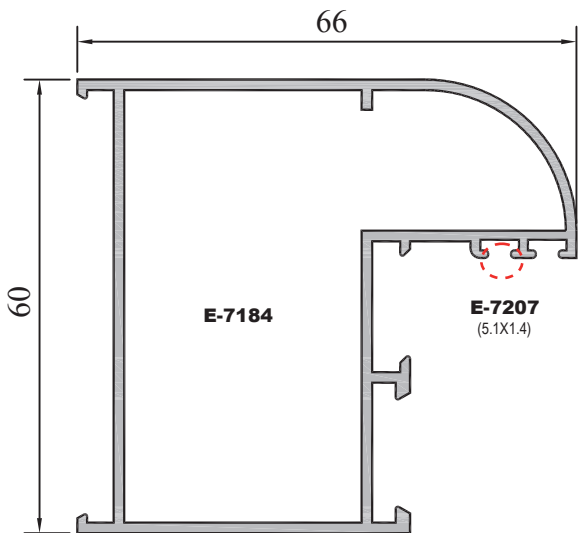

3387 (M-3459)

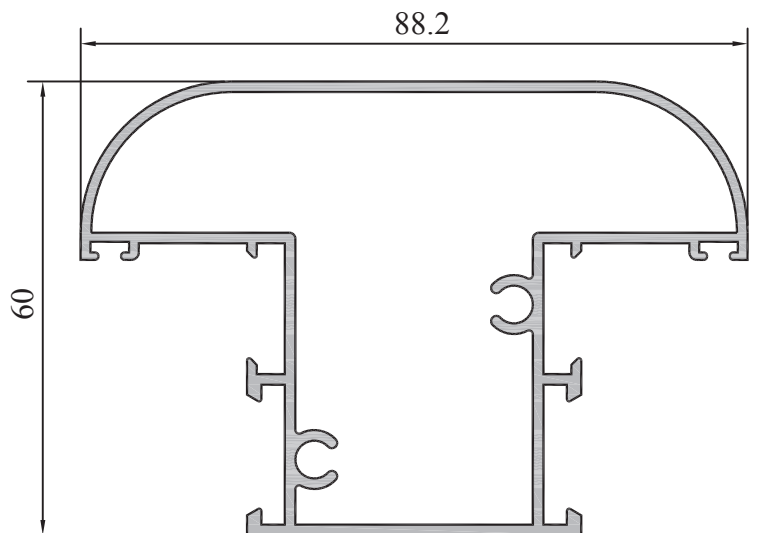

3388 (M-3571)



SERIE 3300 (A-96)

ABATIBLE EUROPEA

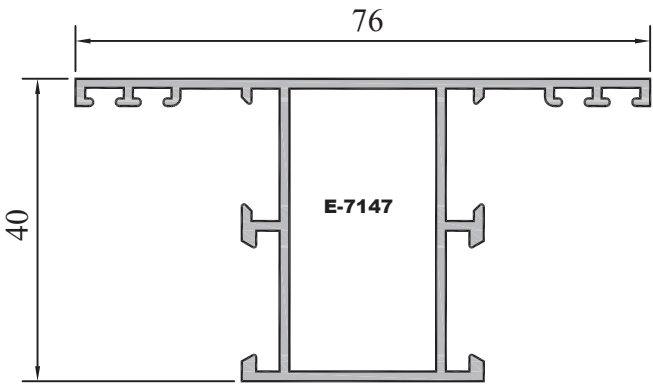

3320 (M-2521)

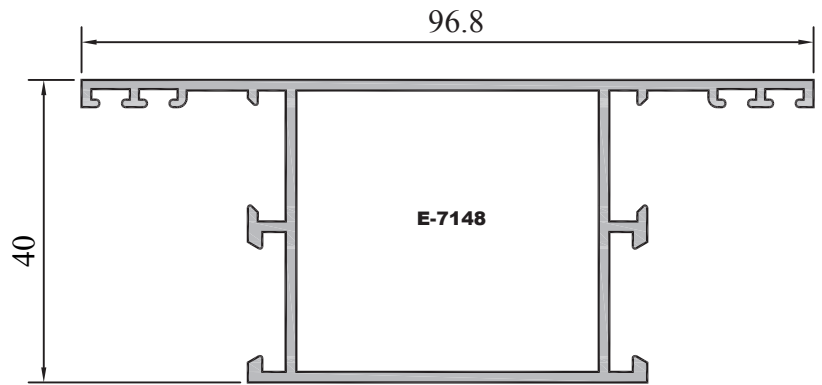

3360 (M-2753)

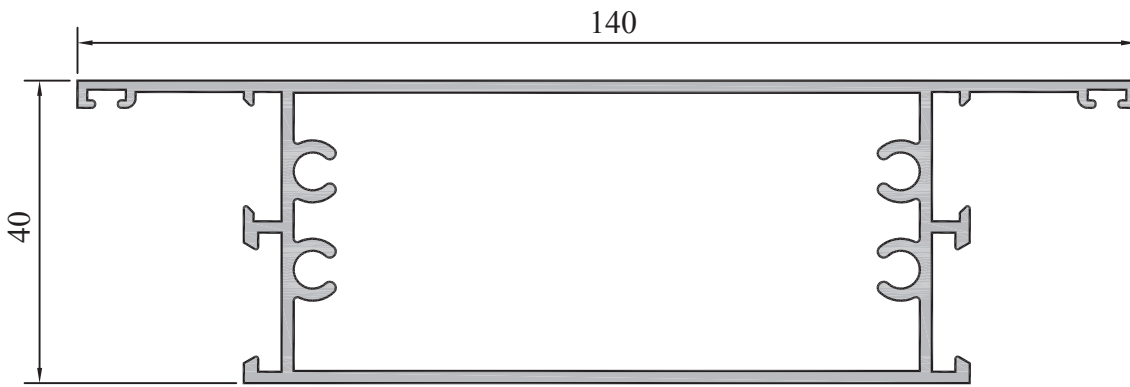

3365 (M-2769)

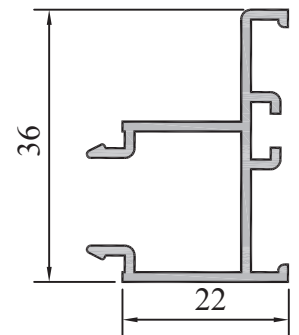

3366 (M-2770)

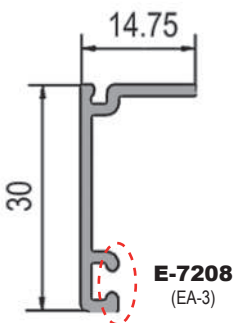

3376 (M-2989)

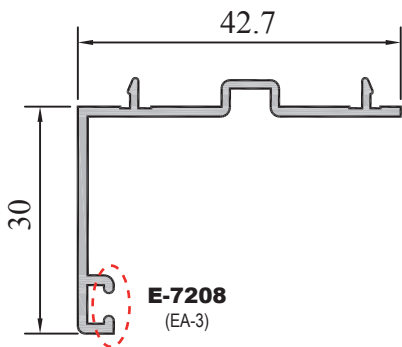

3374 (M-2986)

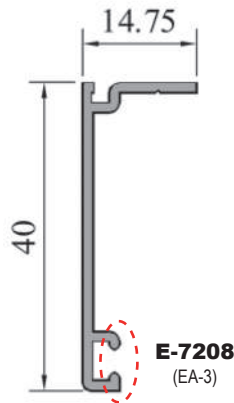

3375 (M-3678)

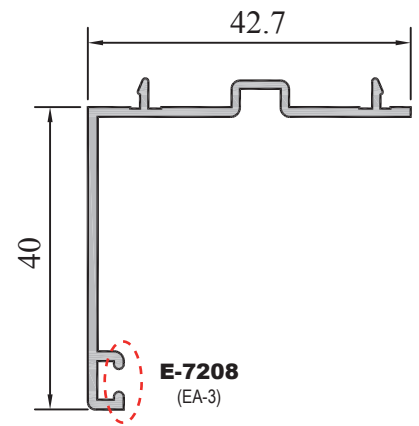

3371 (M-4156)



TABLA DE JUNQUILLOS EN CERCOS, HOJAS Y PILASTRAS

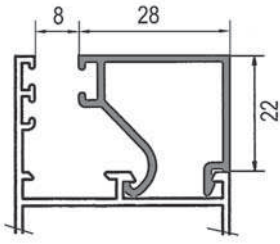

3336 (M-2003)

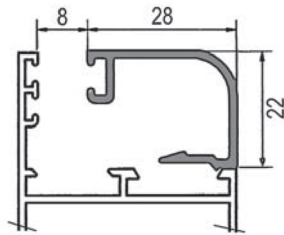

3334 (M-2514)

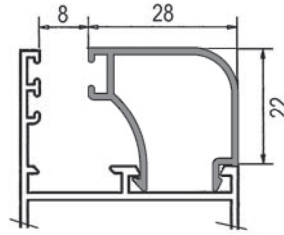

3335 (M-2242)

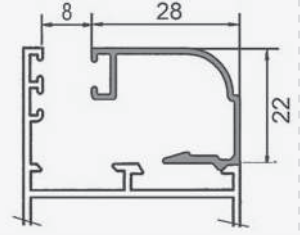

3346 (M-3102)

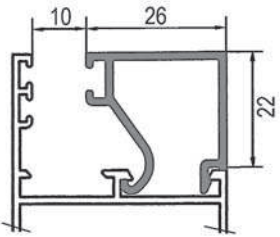

3337 (M-2779)

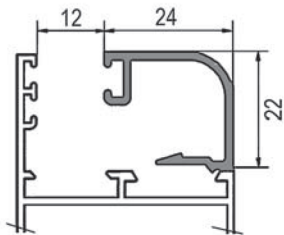

3324 (M-2971)

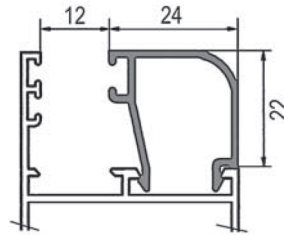

3325 (M-2972)

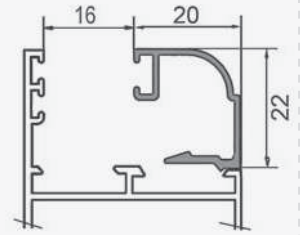

3347 (M-3103)

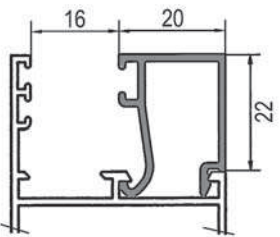

3338 (M-2004)

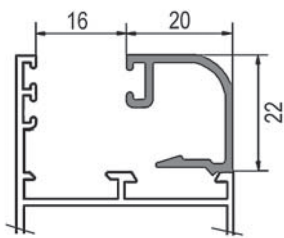

3344 (M-2515)

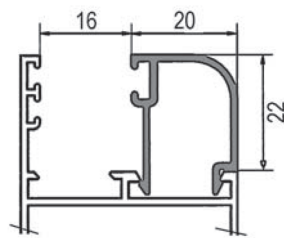

3345 (M-2243)

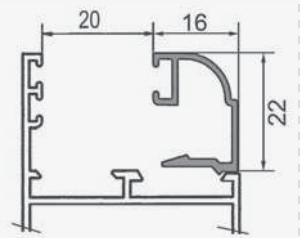

3348 (M-3222)

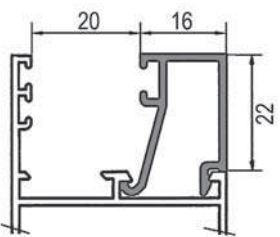

3339 (M-2384)

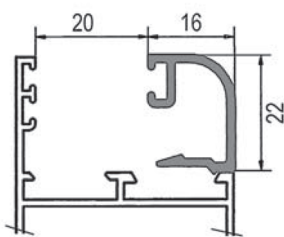

3331 (M-2516)

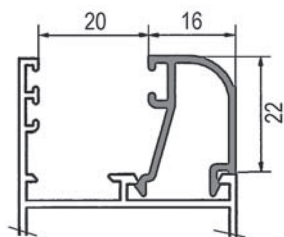

3330 (M-2440)

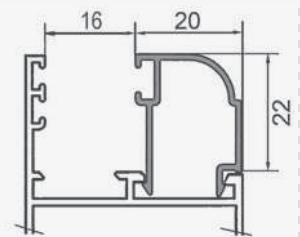

3342 (M-3224)

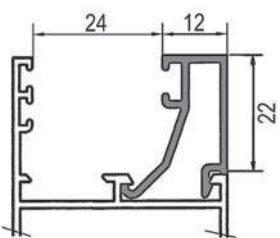

3340 (M-2005)

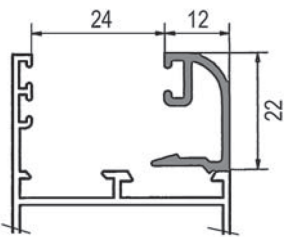

3333 (M-2517)

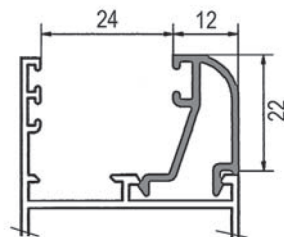

3332 (M-2244)

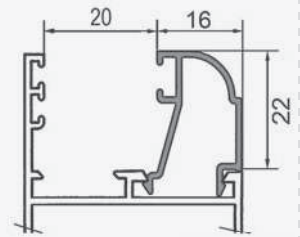

3343 (M-3225)



SERIE 3300 (A-96)

ABATIBLE EUROPEA

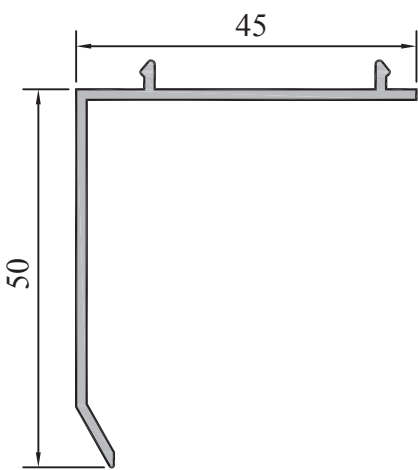

3775 (M-1131)

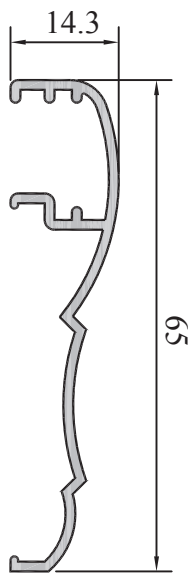

3377 (M-3232)

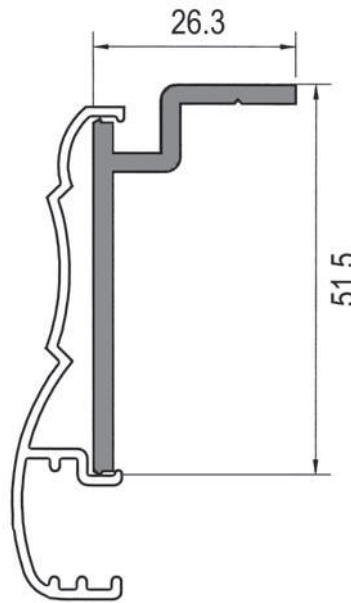

3378 (M-4216)

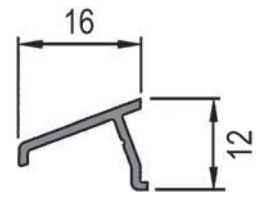

8428

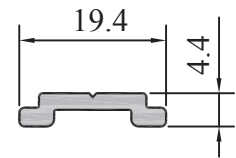

8412 (M-2011)

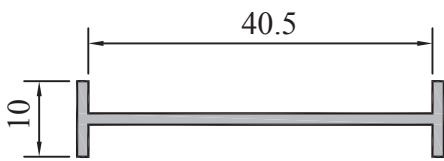

3802 (M-2546)

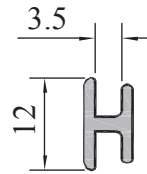

2996 (M-2594)



7900

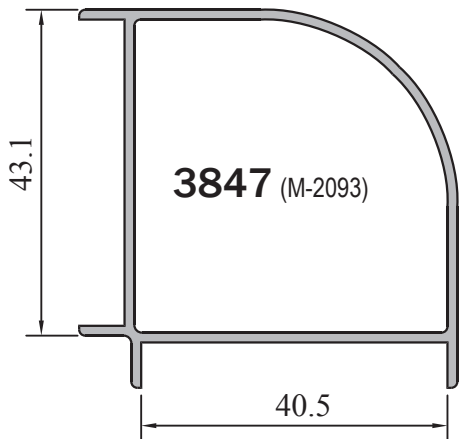

3847 (M-2093)

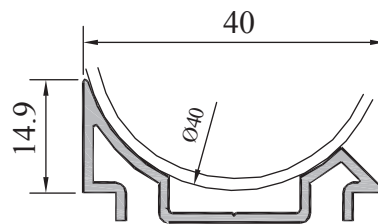

3850 (M-2875)

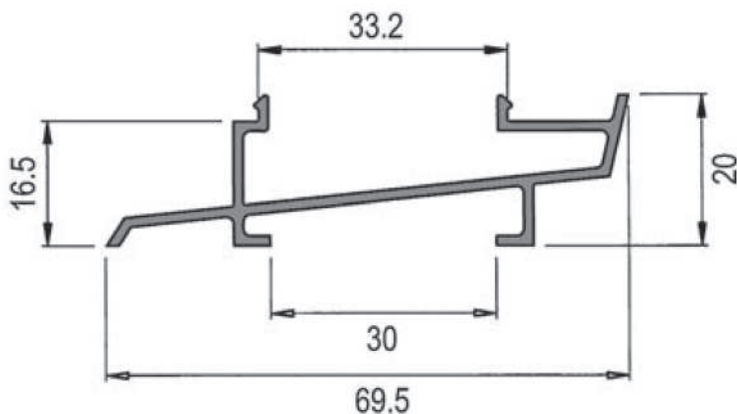

3791

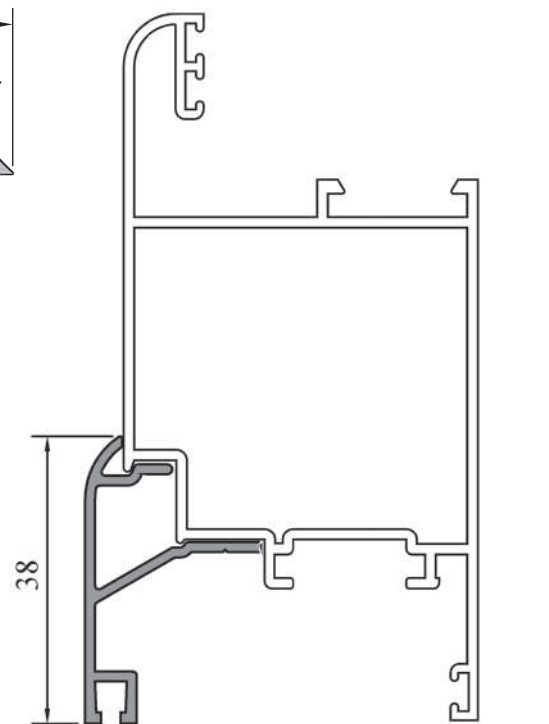

3367 (M-3892)

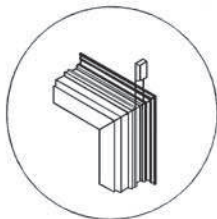
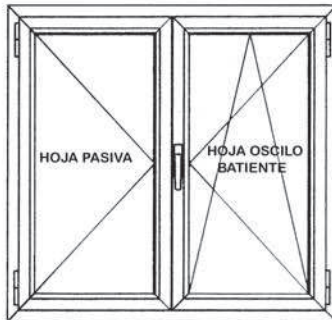
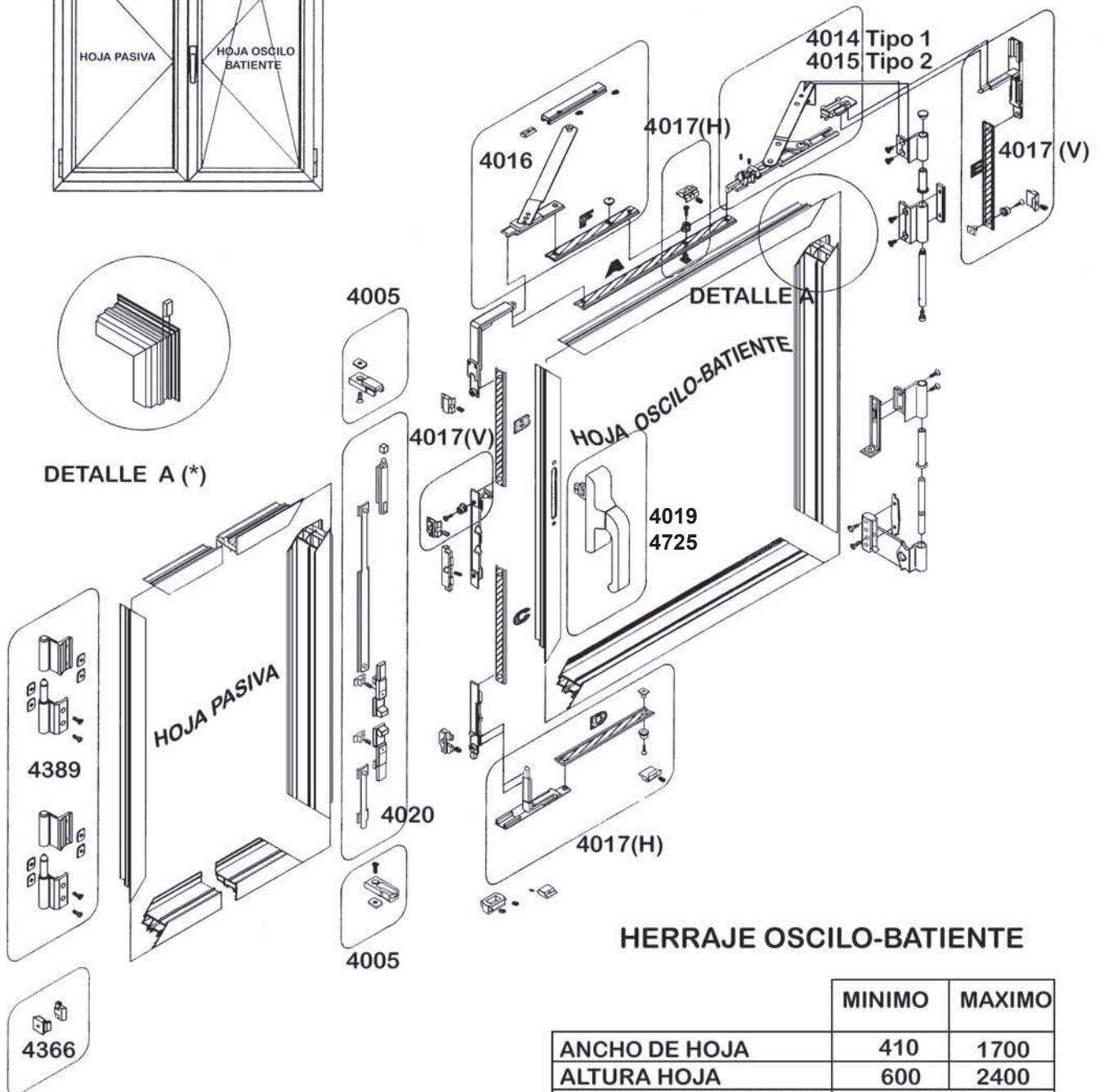

HERRAJE OSCILO - BATIENTE PARA CAMARA EUROPEA

DETALLE A (*)

HERRAJE OSCILO-BATIENTE

	MINIMO	MAXIMO
ANCHO DE HOJA	410	1700
ALTURA HOJA	600	2400
PESO MAXIMO DE HOJA	130 KGS	

EL MECANISMO BASE OSCILO-BATIENTE (REF:4013)
COMPRENDE TODO EL ACCESORIO QUE NO ESTA
INDICADO NI RECUADRADO CON UNA LINEA.

DETALLE A (*) PLANTILLA PARA EL CORRECTO
POSICIONAMIENTO DE LOS BRAZOS TIPO1 O TIPO 2.



HERRAJE OSCILO-BATIENTE

TABLA DE PLETINAS

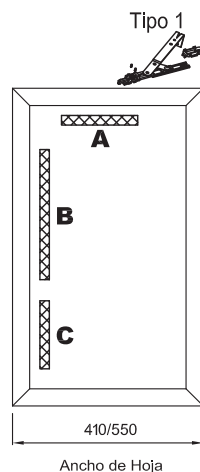
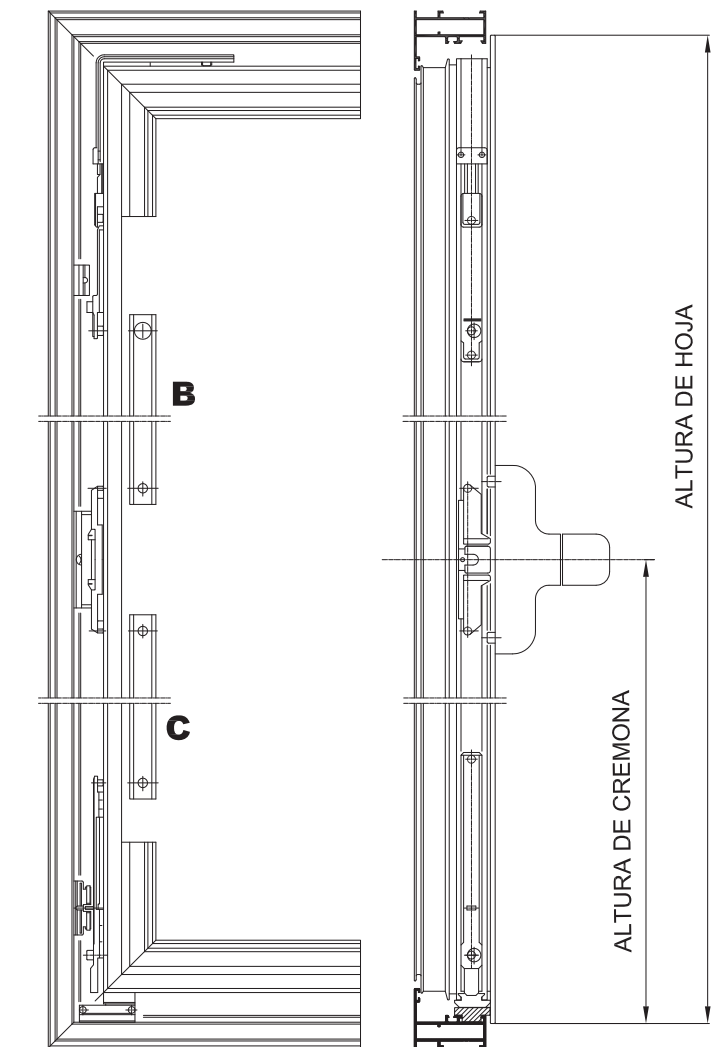

4013
4014
4019

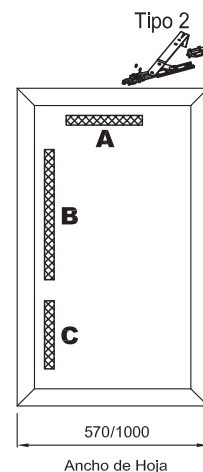

4013
4015
4019

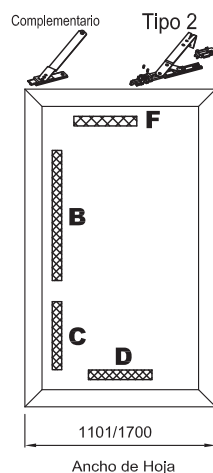

4013
4015
4016
4017
4019

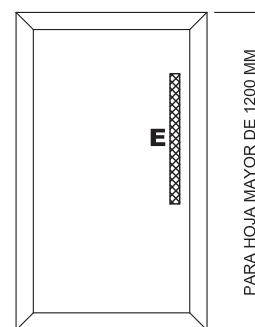

4017



FORMULAS PARA EL CORTE DE LAS PLETINAS

A (Tipo 1) = Ancho de Hoja - 355 mm.

A (Tipo 2) = Ancho de Hoja - 510 mm.

B = Altmra de Hoja - Altmra de Cremona - 207 mm.









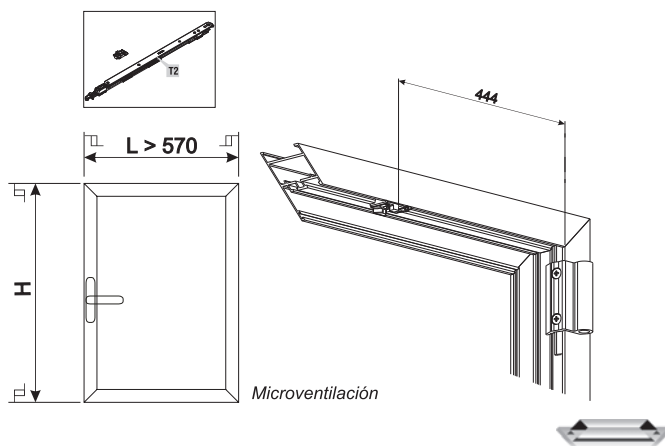
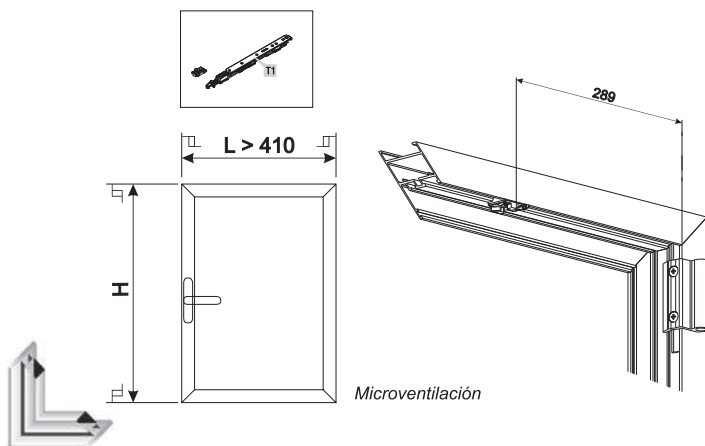

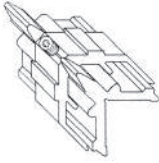

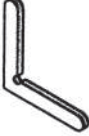

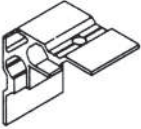
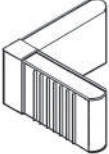



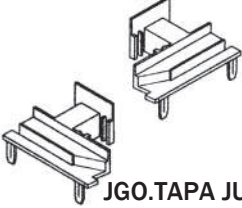

C = Altmra de Cremona - 207 mm.

D = $\frac{\text{Ancho de Hoja}}{2}$ - 69

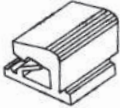
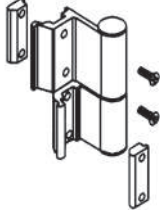
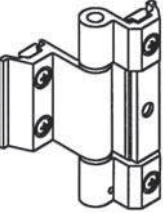
E = $\frac{\text{Altmra de Hoja}}{2}$ - 69

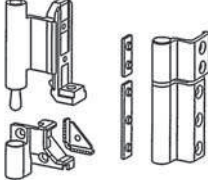
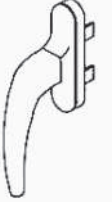
F = Ancho de Hoja - 607 mm.

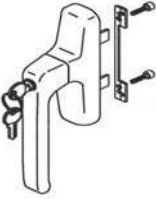
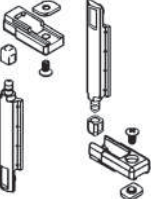
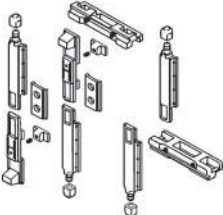











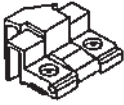
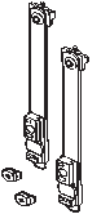

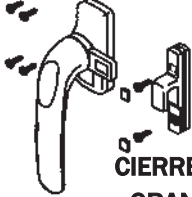
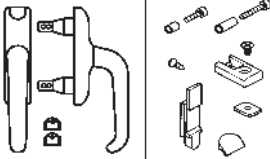

 <p>ESCUADRA VENTANA 7196 (E-1)</p>	 <p>ESCUADRA VENTANA 7143</p>  <p>ESCUADRA PORTADA 7218</p>	 <p>ESCUADRA ALINEAMIENTO 7207 (5.1X1.4)</p>	 <p>SUPLEMENTO PORTADA 7209 (E-4)</p>
 <p>ESCUADRA METALICA PREMARCO PEQUEÑO 7170</p>	 <p>ESCUADRA PLASTICO PREMARCO PEQUEÑO 7137</p>	 <p>UNION PILASTRA 7147 (1819)</p>  <p>UNION PILASTRA PORTADA 7148 (1840)</p>	 <p>GOMA CENTRAL DE CERCO 7713(T-626)</p>
 <p>GOMA RIGIDA EXT.CERCO 7708 (303049C1)</p>  <p>GOMA EXTERIOR CERCO 7725 (T-888)</p>	 <p>GOMA HOJA PERIMETRAL 7711 309.047)</p>  <p>GOMA HOJA PERIMETRAL PDM 7716 (T-902)</p>	 <p>CORNER 7719 (C-626)</p>	 <p>JGO.TAPA JUNTAS INVERSORA 7203 (TI-1)</p>
 <p>TAPA SALIDA DE AGUAS 4035 (DF-1)</p>	 <p>NUDO JUNQUILLO 7216</p>	 <p>GRAPA JUNQUILLO 4078 (GR-1)</p>	 <p>BISAGRA 4389</p> <p>BI - 7015 SA - 7007</p>
 <p>BISAGRA 3 PALAS 7014</p>	 <p>BISAGRA ORION 145 PORTADA 7017</p>	 <p>BISAGRA SIMETRICA HOJA PASIVA 4724</p>	 <p>CREMONA 4024</p>  <p>4723</p>
 <p>CREMONA LLAVE 4761</p>	 <p>KIT 1 HOJA 4058</p>	 <p>KIT 2 HOJAS 4059</p>	 <p>PASADOR 4002</p>

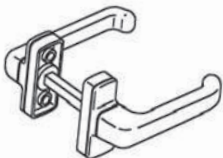
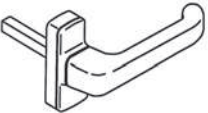
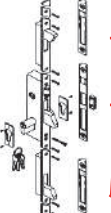
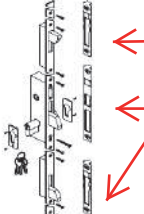
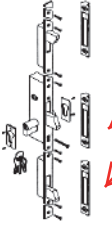

SERIE 3300 (A-96)

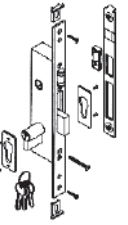
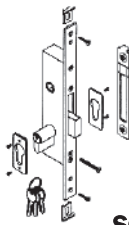
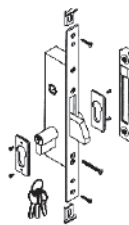
ABATIBLE EUROPEA

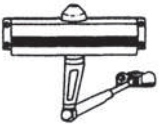

 <p>CANGREJO 4009</p>	 <p>COMPAS LARGO 4085 CORTO 4010</p>	 <p>COMPAS TELESCOPICO 4011</p>	 <p>CIERRE PRESION GRANDE 7059 PEQUEÑO 7065</p>
 <p>CREMONA APERTURA EXT. 7033</p> <p>KIT 7034</p>	 <p>TIRADOR 2 CODOS 7114</p>		 <p>TIRADOR CURVO 7115</p>
 <p>TIRADOR AUSTRAL 7111</p>	 <p>JUEGO MANILLAS RECUPERABLES 7107</p>	 <p>MANILLA RECUPERABLE 4031</p>	 <p>7058</p> <p>7057</p> <p>CERRADURA MULTIPUNTO RODILLO - PALANCA 7304</p>
 <p>7058</p> <p>7057</p> <p>CERRADURA MULTIPUNTO RESBALON - PALANCA 7306</p>	 <p>7058</p> <p>CERRADURA MULTIPUNTO SOLO PALANCA 7308</p>	 <p>CERRADERO 2 ENTRADAS 7057</p> <p>CERRADURA RESBALON - PALANCA 7310</p>	 <p>CERRADERO 2 ENTRADAS 7057</p> <p>CERRADURA RESBALON - FRONTAL 7312</p>
 <p>CERRADERO 2 ENTRADAS 7057</p> <p>CERRADURA RODILLO - PALANCA 7314</p>	 <p>CERRADERO 2 ENTRADAS 7057</p> <p>CERRADURA RODILLO - FRONTAL 7316</p>	 <p>CERRADERO 1 ENTRADA 7058</p> <p>CERRADURA SOLO FRONTAL 7318</p>	 <p>CERRADERO 1 ENTRADA 7058</p> <p>CERRADURA SOLO PALANCA 7320</p>
 <p>SOLO RESBALON 7590</p>	 <p>CERRADERO ELECTRICO RESBALON - PALANCA FRONTAL 7612</p>	 <p>CERRADERO ELECTRICO 7610</p>	 <p>MUELLE RETENCION 80KG 7141 100KG 7142</p>